

教育机器人教师培训

第2课：移动机器人小车搭建



C202WER比赛套装底座用料图



正立方体
*7



半高立方体
*6



平板(1#)
*5



平板(2#)
*2



平板(8#)
*1



轴套
*27



3倍销
*23



3孔梁
*14



90度3x5梁
*15



126.87度4x6梁
*4



7孔梁
*21



11孔梁
*6



2倍销
*49



L型件
*7



H型件
*1



短插销
*6



A型件
*4



轴承
*2



轴(40mm)
*2

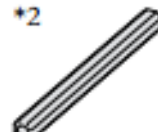

轴(60mm)
*6

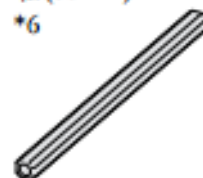

轴(80mm)
*8



齿轮(12-tooth)
*4



齿轮(20-tooth)
*2



齿轮(28-tooth)
*3



齿轮(12/28-tooth)
*1



立方体连接器
*4



轮胎
*2



导向轮
*1



180度联轴器
*4



90度联轴器
*4



灰度传感器
*5

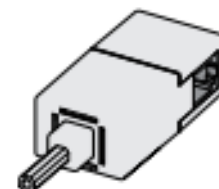

电机
*1

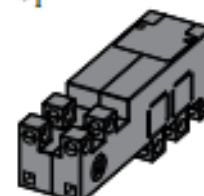

闭环电机
*2



控制器(102)
*1

正立方体

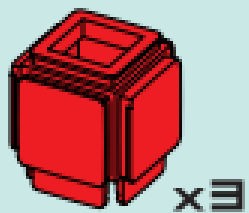

x3

平板 (8#)

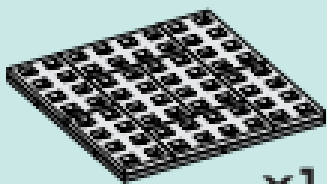

x1

短插销

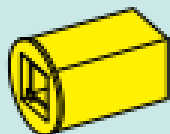

x2

L型件

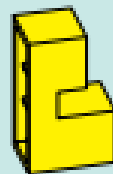

x2

轴 (40mm)

S40



x2

轴 (60mm)

S55



x2

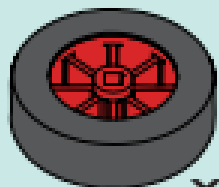

x2

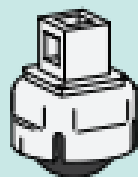

x1



x2

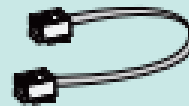

x2



x1



x1

轮胎

导向轮

闭环电机

电机线

控制器 (102)

控制器电池

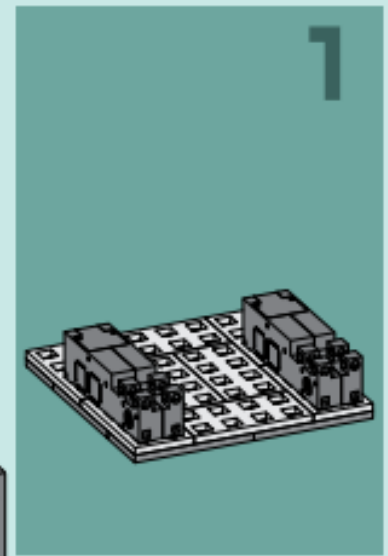
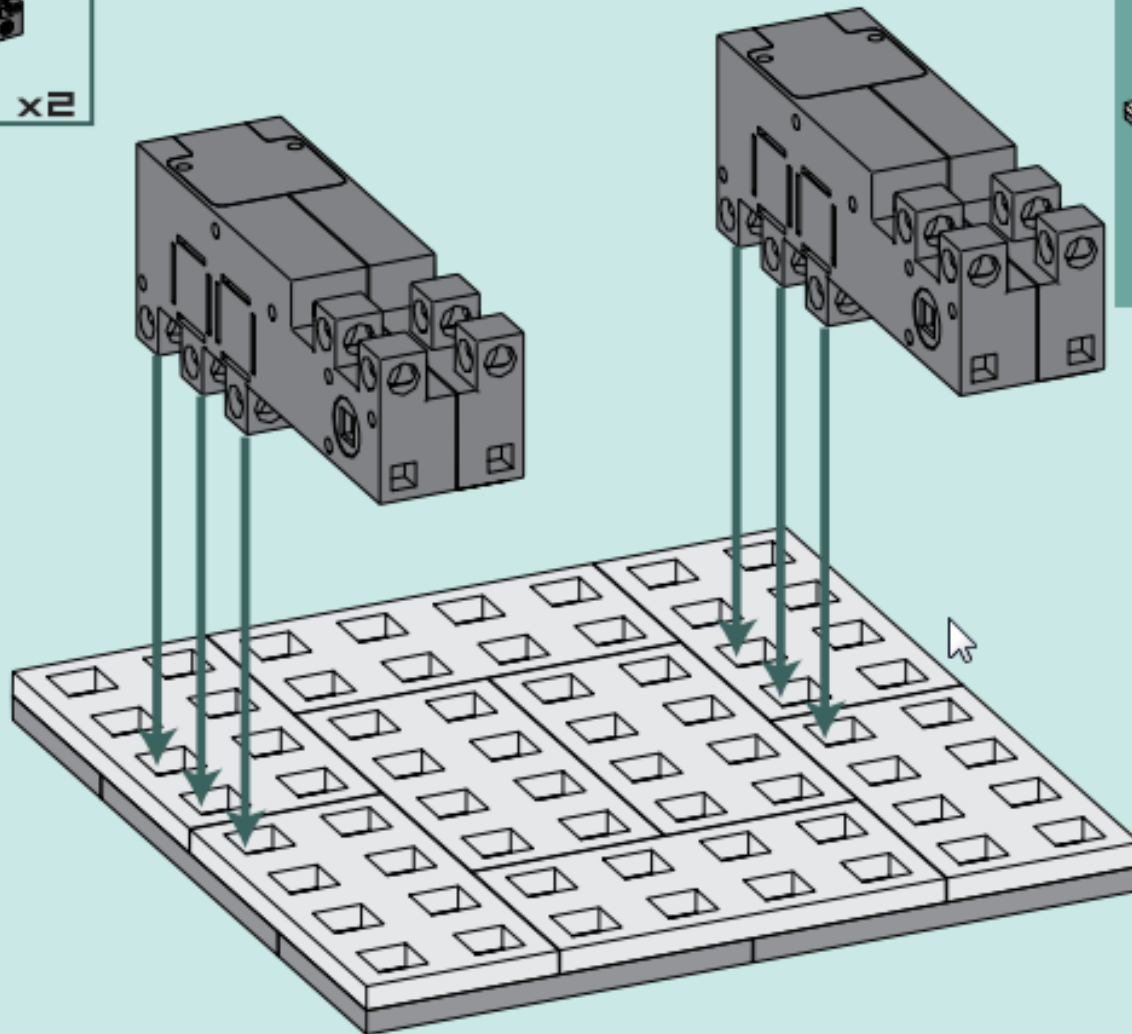

2

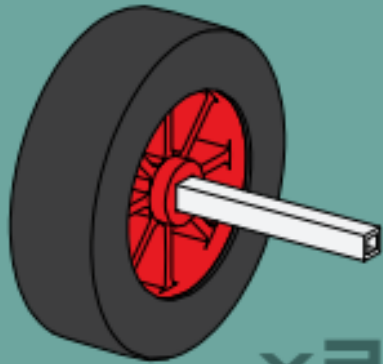

x2

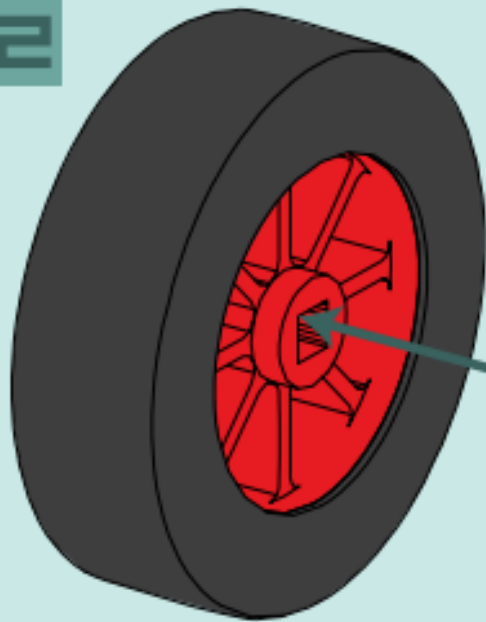

S55

S55



x2



x2

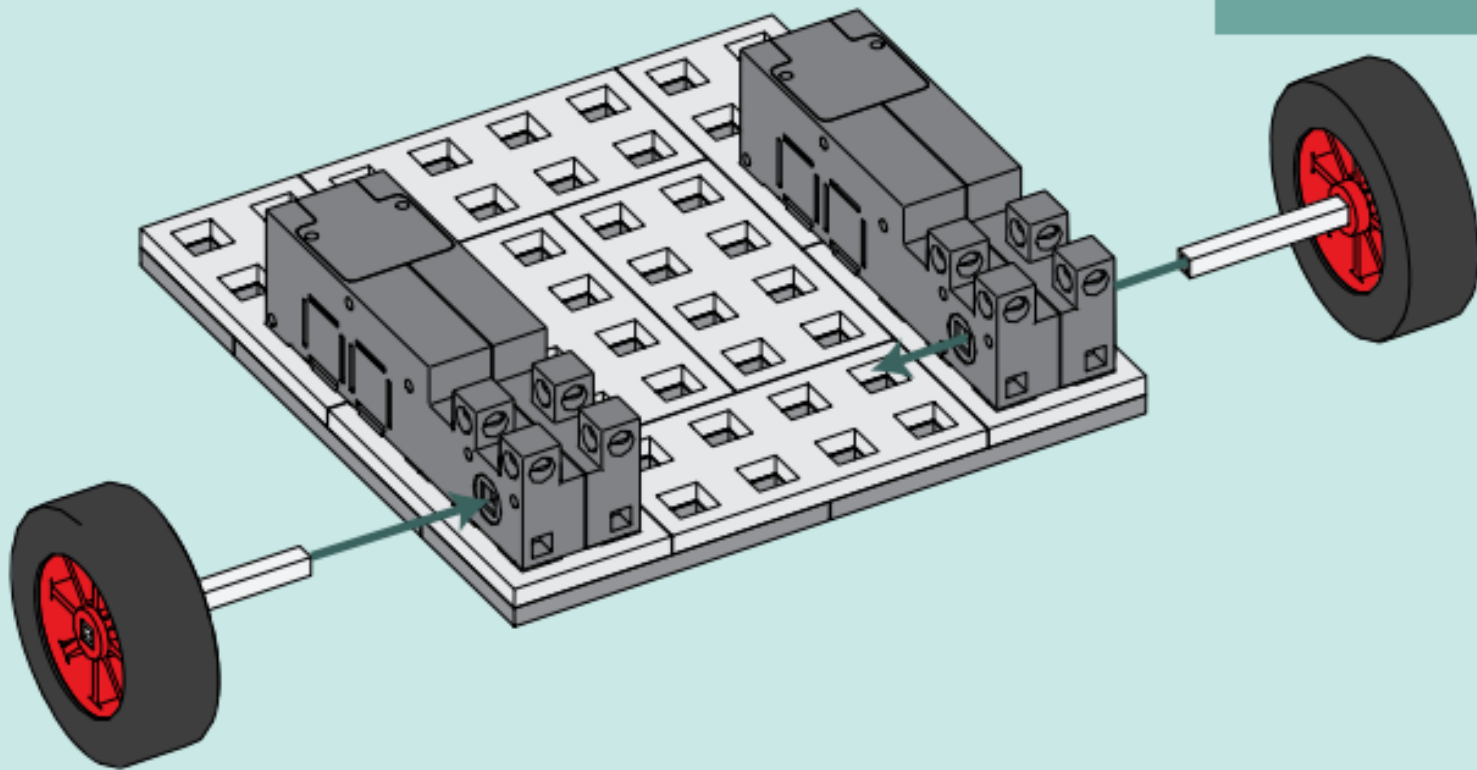
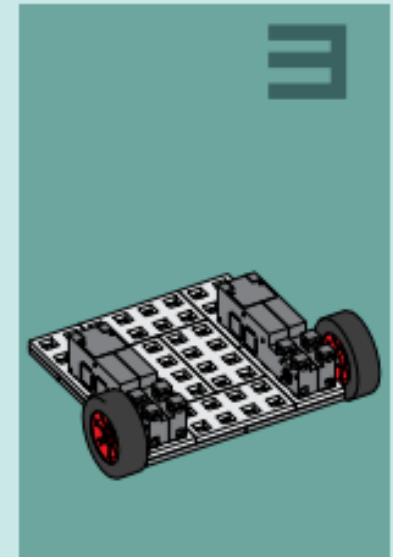
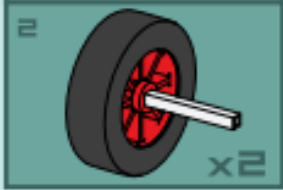

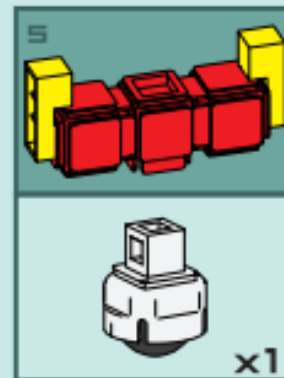
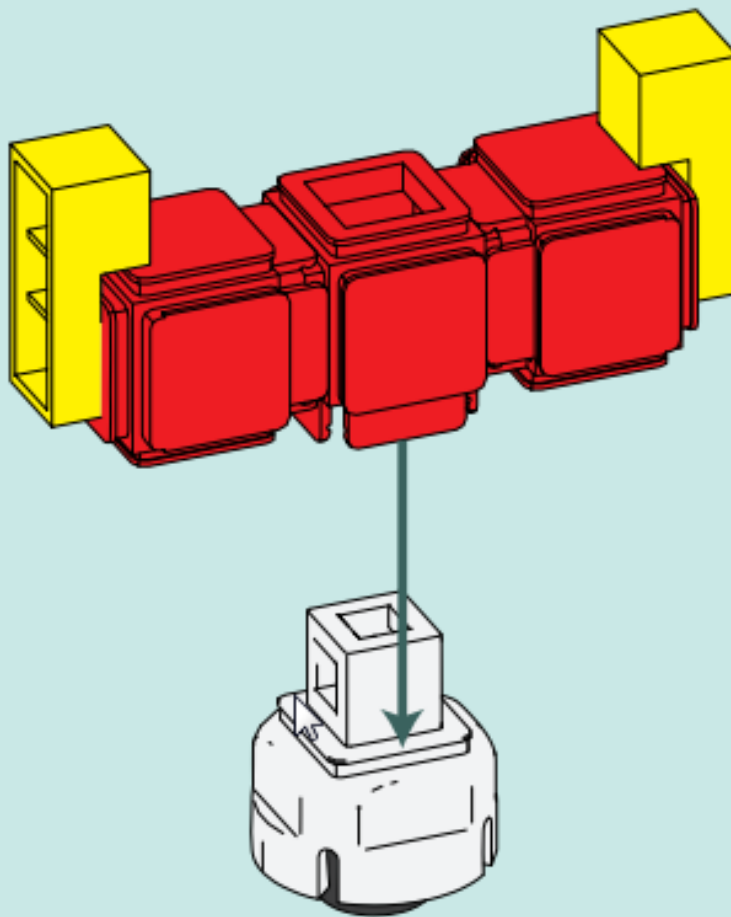
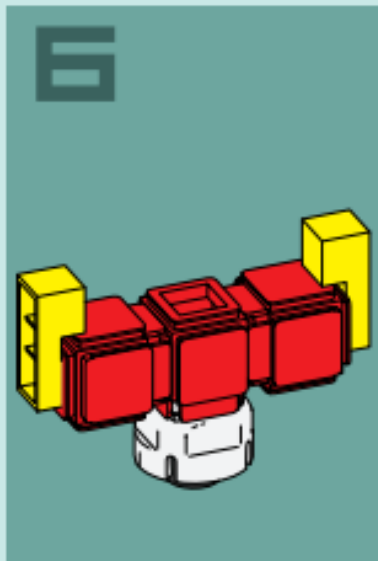

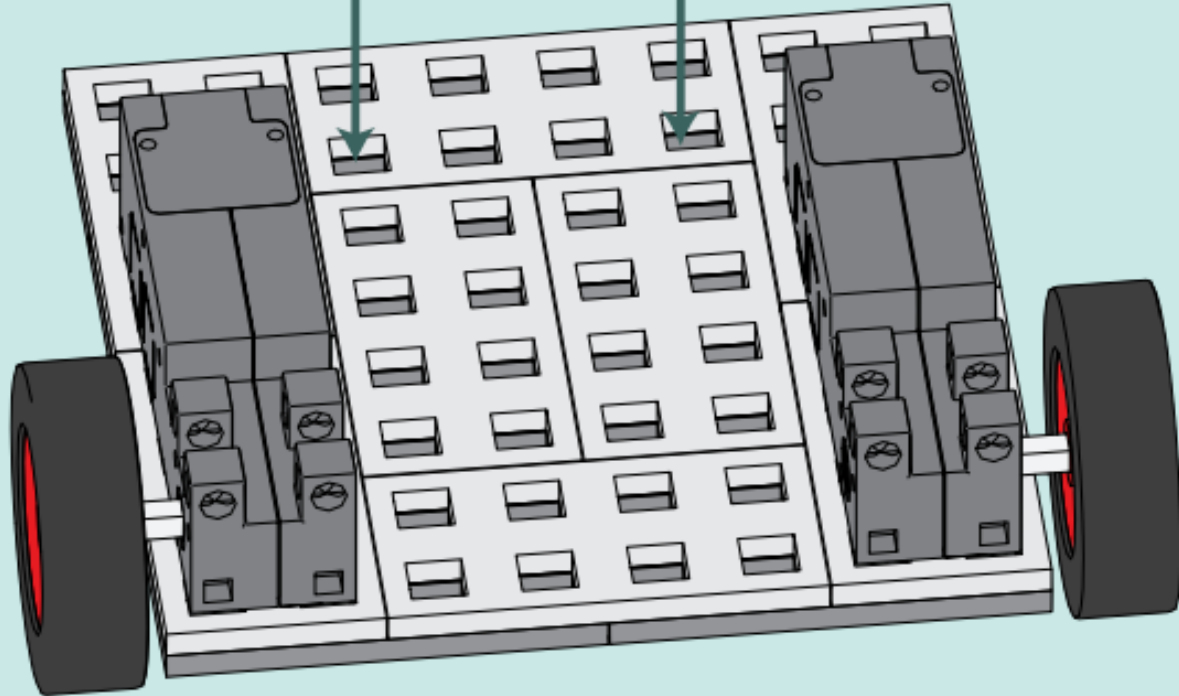
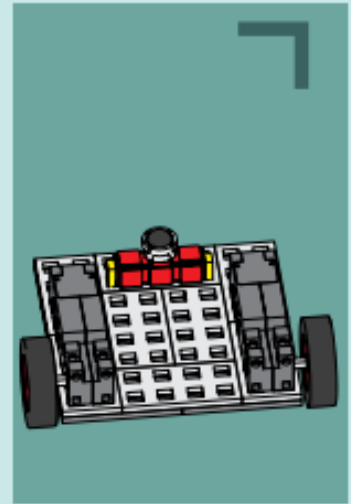
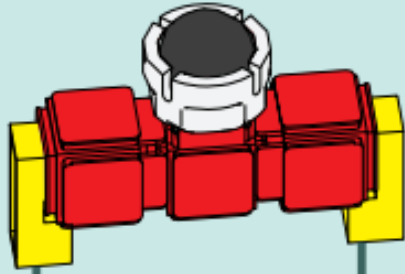
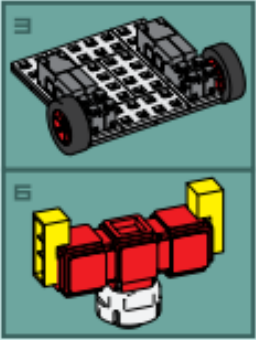

10

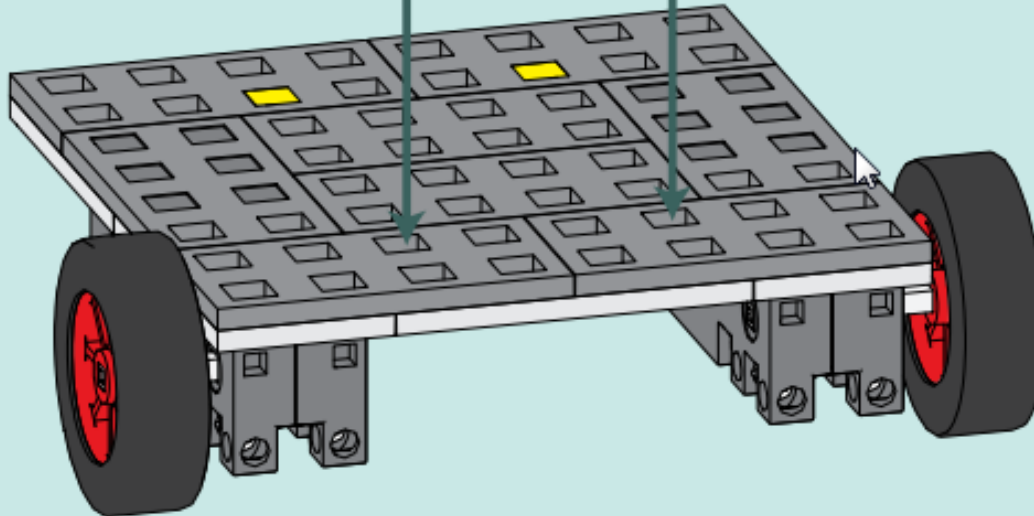
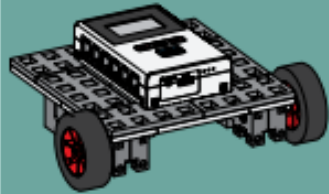

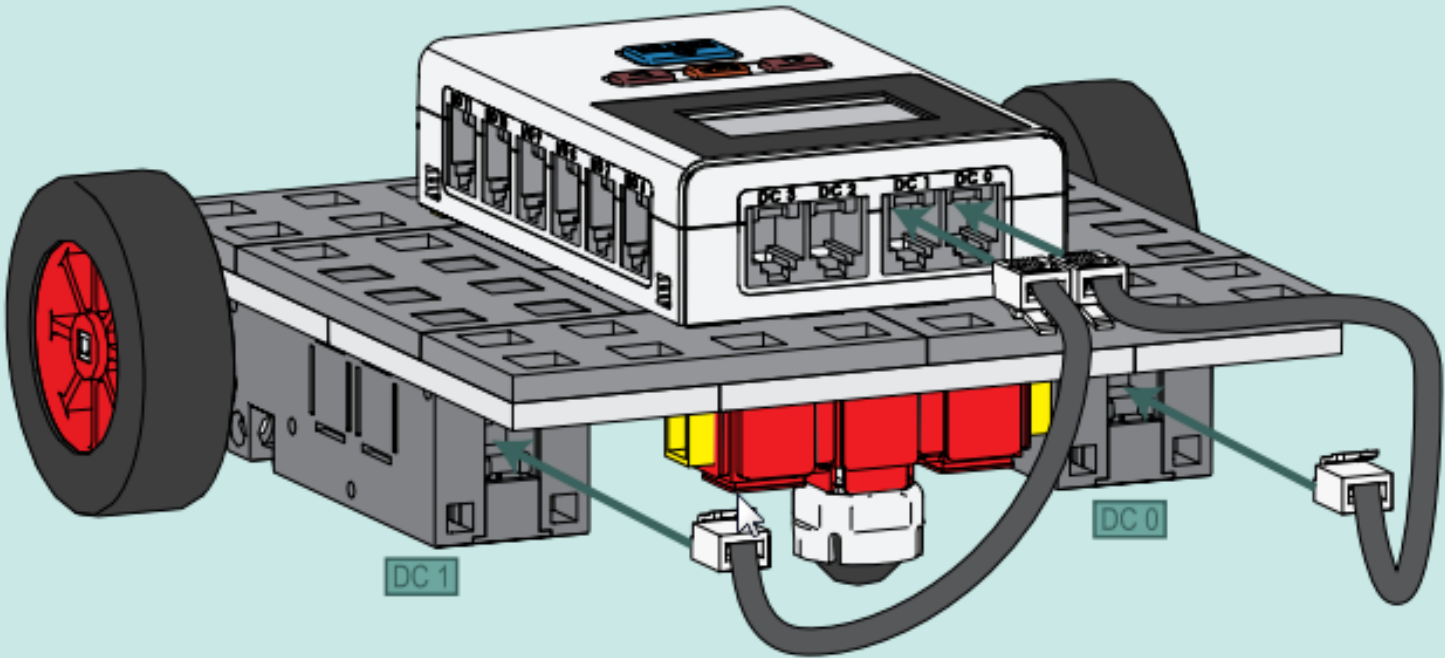
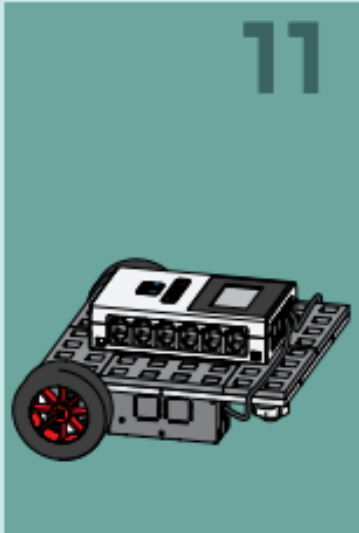
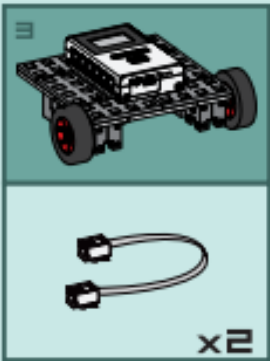

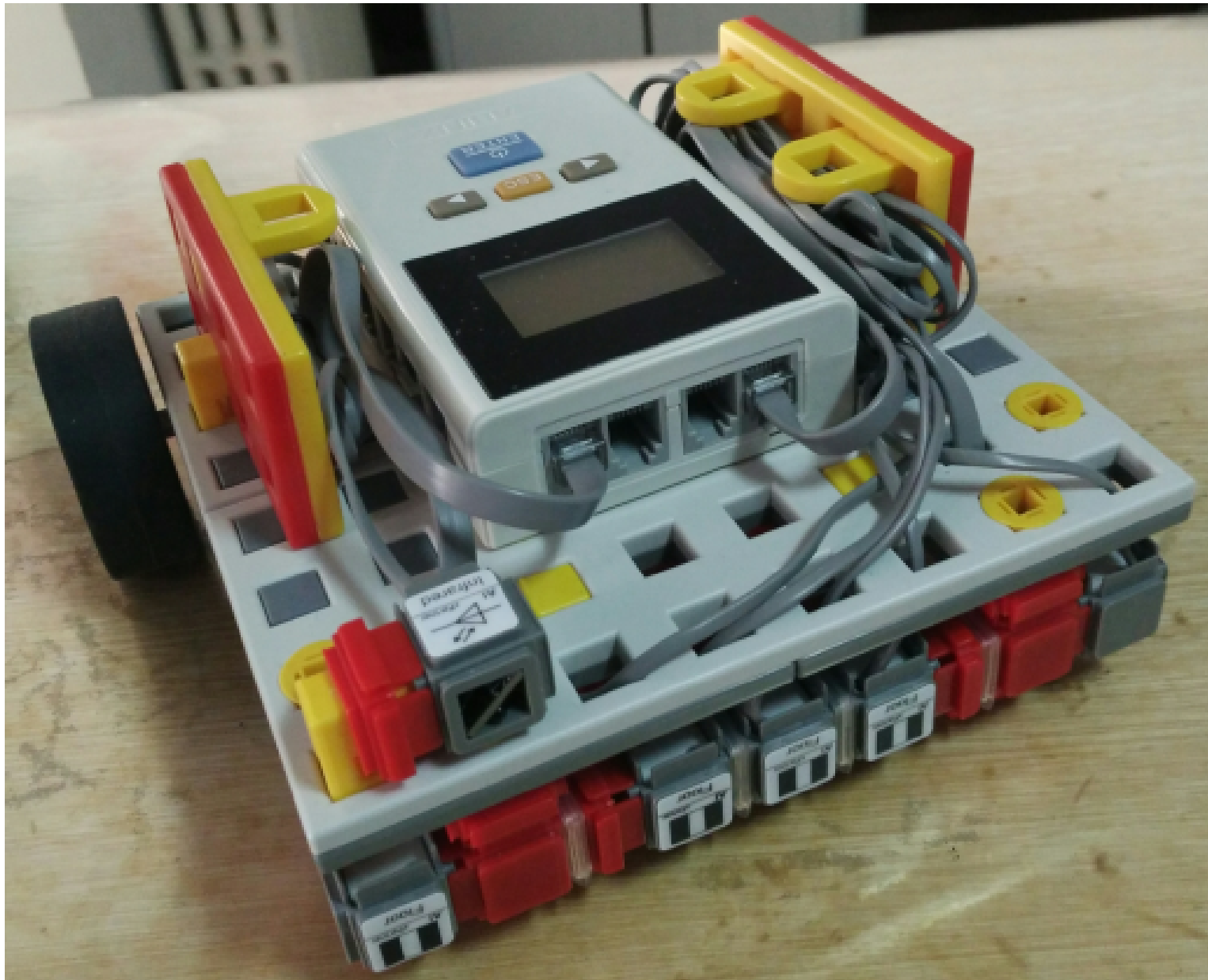

来全国少儿文化艺术教育考评管理中心

感受教育机器人的
无穷魅力吧！

